

Moduli monorelè equipaggiati con relè ribassato o con relè ad alta capacità
Single relay modules equipped with low profile or high capacity relay

Portata contatti: 10A 250V per i moduli con relè ribassato
16A 250V per i moduli con relè ad alta capacità

Contact capacity: 10A 250V for low profile modules
16A 250V for high capacity modules

Segnale di comando in tensione continua (Vcc) oppure universale (Vca/cc)
Direct current (Vdc) or universal (Vac/dc) drive signal

Uscita: in scambio per i moduli ad alta capacità
in scambio oppure con contatto normalmente aperto per i moduli con relè ribassato

Output: SPDT for high capacity modules
SPDT or normally open for low profile modules

Led giallo: indicazione relè eccitato e presenza alimentazione
Yellow led: relay ON indication and supply ON

Connessioni di ingresso e di uscita: morsettiere a vite per conduttori diam. max 2,5mm²
Input and output connections: screw terminal for leads max diam. 2,5mm²

Diodo di sicurezza, contro l'inversione della polarità sul circuito di alimentazione
Security diode for supply reverse polarity protection

Diodo antiparallelo sulla bobina di eccitazione
Clamping diode on excitation coil

Circuito stampato doppio strato (approv. UR)
Dual layer PCB (UR approval)

Supporto in materiale autoestinguente UL 94-V0
UL 94-V0 self-extinguishing case

Esecuzione per aggancio su barra DIN EN50022 e EN50035
Execution for DIN EN50022 and EN50035 rail mounting

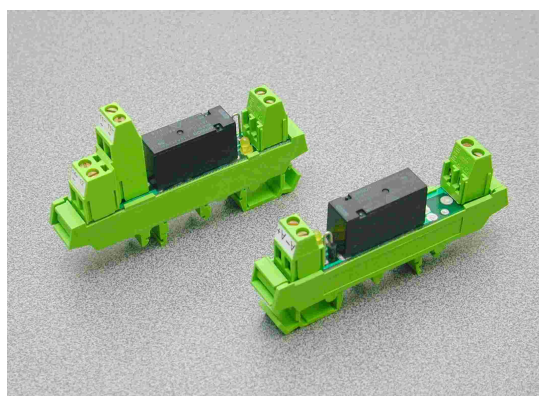
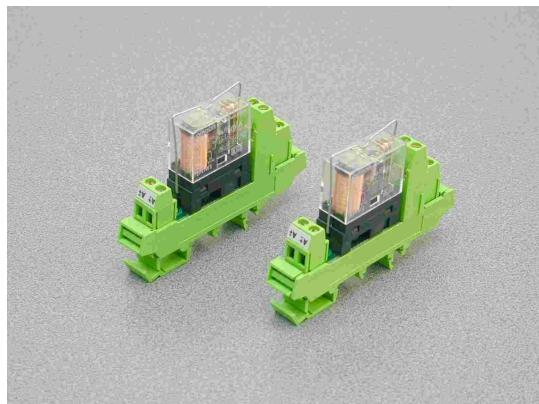

SCHEMI ELETTRICI / WIRING DIAGRAMS

COMANDO CC
DC CONTROL

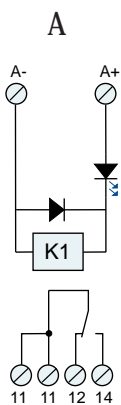

COMANDO UNIVERSALE (CA-CC)
UNIVERSAL CONTROL (AC-DC)

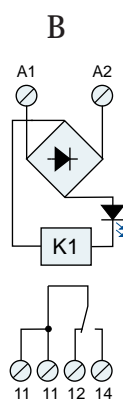

COMANDO CC
DC CONTROL

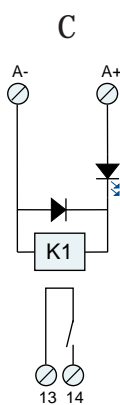

COMANDO CC
DC CONTROL

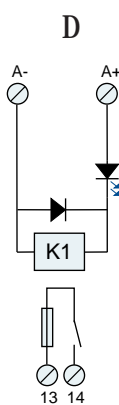

COME ORDINARE - HOW TO ORDER

Sigla Part Number	Cod. Code	*	Comando Drive signal	Uscita Output	Sigla Part Number	Cod. Code	*	Comando Drive signal	Uscita Output
ET-MRZ01/24DC/SC/16A	0015	A	24dc	scambio SPDT	ET-MR01/24DC/SC/16A	0003	A	24dc	scambio / SPDT
ET-MRZ01/48DC/SC/16A	0016	A	48dc		ET-MR01/48DC/SC/16A	0007	A	48dc	
ET-MRZ01/110DC/SC/16A	0018	A	110dc		ET-MR01/110DC/SC/16A	0009	A	110dc	
ET-MRZ01/24AC-DC/SC/16A	0025	B	24Vac/dc	scambio / SPDT	ET-MR01/24DC/SC/LP	0488	A	24Vdc	scambio / SPDT
ET-MRZ01/48AC-DC/SC/16A	0026	B	48Vac/dc		ET-MR01/24DC/NO/LP	0489	C	24Vdc	
					ET-MR01/24DC/NO/F/LP	0490	D	24Vdc	NA + fusibile NO +fuse

* Riferimento schema elettrico relativo - Reference to wiring diagram

DIMENSIONI MONORELE' / SINGLE RELAY DIMENSIONS

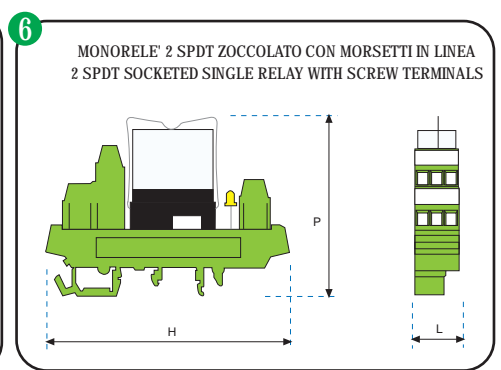
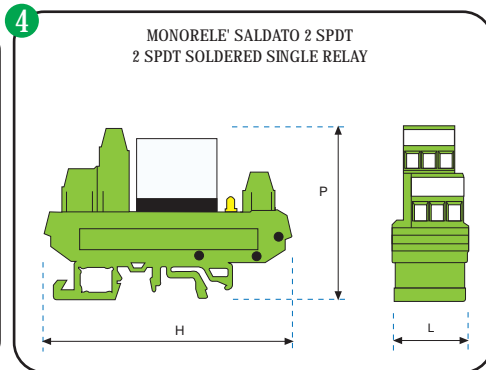
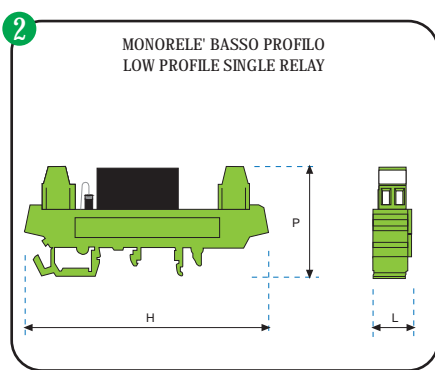
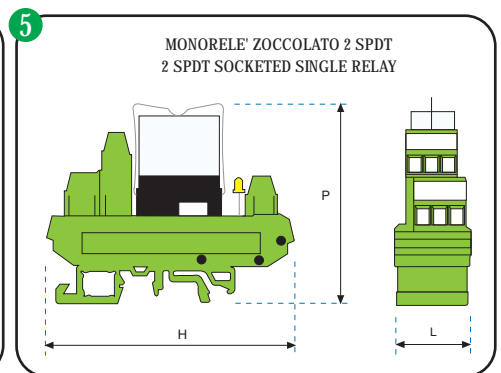
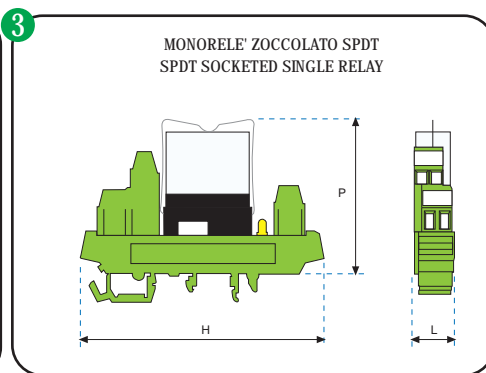
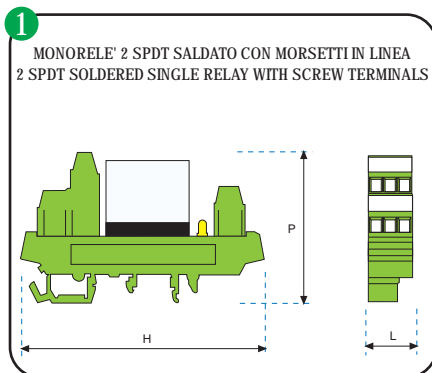

VISTA DI MONTAGGIO SU BARRA DIN / DIN RAIL MOUNTING VIEW

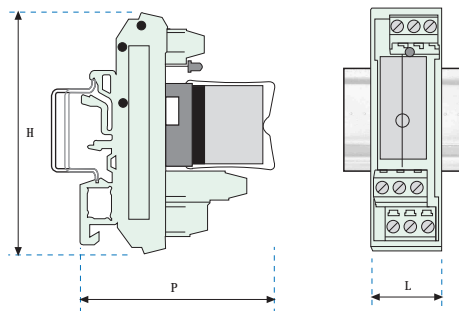

NOTA: moduli adatti per aggancio su barra DIN EN50022 e EN50035
NOTE: modules suitable for DIN EN50022 and EN50035 rail mounting

TIPO / TYPE	DIMENSIONI / DIMENSIONS (mm)		
	L / W	H	P / D
1 MONORELE' 2 SPDT SALDATO CON MORSETTI IN LINEA / 2 SPDT SOLDERED SINGLE RELAY WITH SCREW TERMINALS	16	84,5	56
2 MONORELE' BASSO PROFILO SALDATO / LOW PROFILE SINGLE SOLDERED RELAY	13	84,5	38
3 MONORELE' SPDT ZOCCOLATO / SPDT SOCKETED SINGLE RELAY	13	84,5	62
4 MONORELE' 2 SPDT SALDATO / 2 SPDT SOLDERED SINGLE RELAY	23	84,5	51
5 MONORELE' 2 SPDT ZOCCOLATO / 2 SPDT SOCKETED SINGLE RELAY	23	84,5	68
6 MONORELE' 2 SPDT ZOCCOLATO CON MORSETTI IN LINEA / 2 SPDT SOCKETED SINGLE RELAY WITH SCREW TERMINALS	16	84,5	65